



AQUBE® MH7

Fully automatic state of the art PowerSpray® XL "allround" cleaning system for tools and maintenance cleaning

Cleans solder frames, solder carriers, solder pallets, ESD boxes, PCB magazines, trays, machinery parts

Capacity: 11 carriers 710 x 580, 28" x 23" or 640 x 640 mm, 25" x 25" or up to three drawer baskets for small parts

Part number: 0905AQ7MH11 / 0905AQ7MH21 (HT version)



Certifications:

This system in its basic version was certified for its energy and water saving processing, for easy operability and for the standard integration of comprehensive safety features.

- * Two tank system with triple circuit function
- * Intelligent network connectivity for implementation in industry 4.0 smart factories
- * Fully automatic 3step (optional up to 5Step): cleaning, rinsing (tap water), VMH®-Turbo evaporative drying
- * Horizontal PTFE mounted rotor system with asynchronous spray rotors for thorough wetting (no blind spots)
- * Horizontal cleaning of stencils possible with special drawer option
- * ClosedLoop reprocessing of cleaning and rinsing fluids as standard feature
- * Process and service intervals PLC controlled
- * Event issuing and software control via touch screen
- * EDGELESS Design and VARAccess® service access: maximum capacity, easy maintenance on a very small footprint
- * HT version for high temperature cleaning and rinsing up to 80 °C available

Key applications

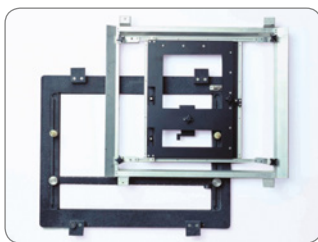

Solder frames, carriers



ESD boxes, magazines



Machinery parts



Condensation filters

The new kolb AQUBE® series offer next-generation cleaning systems - even more efficient, even more compact, easy to handle and maintain, pre-equipped for extended water management and cyber-physically ready for the smart factory (SF ready).

AQUBE® MH7 is a XL "allround" cleaning system with a large process chamber for almost every requirement of tools and maintenance cleaning such as the cleaning of carriers, containers and parts from flux residues, oil dust and grease.

The two-tank and triple circuit configuration ensures short cycle times and makes this system the perfect economic choice for the maintenance cleaning in electronics production..

The cleaning system can be operated with all common electronics cleaning supplies (detergents / chemistry, etc.) which are approved by the manufacturer.







AQUBE® MH7



Fully automatic state of the art PowerSpray® XL "allround" cleaning system for tools and maintenance cleaning

Part number: 0905AQ7MH11 / 0905AQ7MH21 (HT version)

Application overview

Optional suitable	Optional suitable	Most suitable	Most suitable	Optional suitable
				
Assembled PCBs Hybrids Misprints	Stencils Screens, PumpPrints Misprints	Solder frames Solder carriers Solder masks	ESD Boxes Containers Magazines	Condensation traps Filters Steel sheets

Optional suitable applications can also be optimally realized with the appropriate options.

Cleaning (key process 1): From the cleaning tank (A) the cleaner liquid is sucked by a magnetically coupled pump unit and routed with a controllable volume flow through a separate circuit into the PTFE mounted ASYNCHRO® stainless steel spray rotors with patented PUSHFORCE® nozzles. Their geometry ensures a comprehensive and thorough cleaning, even in inaccessible and critical areas. After the washing procedure, the valve switchover of the process chamber undocks the cleaning circuit until the next process run.

MediumWipe® (optional intermediate process): The remaining cleaner is blown off from the clean products and blown out of the cleaner circuit and recirculated into the cleaning tank before the valve switchover closes.

Rinsing with tap water (key process 2): From the rinsing tank (tank B / C), the water is pumped through the separate second circuit into the spray rotors. Tap water has (compared to DI / DM water) the advantage of lower surface tension and thus flushes also critical points as low standoffs more efficient.

MediumWipe® (optional intermediate process): The remaining water is blown off from the products and blown out of the cleaner circuit and recirculated into the rinsing tank.

Clear rinsing with DI / DM water (optional process): The DI / DM water is produced from tap water in an integrated MB-cartridge and flushes conducting ions of the previous processes. This process is repeated automatically until the remaining amount of ions falls below the programmed value.

MediumWipe® (optional intermediate process): Blowing off and recirculating the remaining DI / DM water into the rinsing tank.

Drying (key process 3): The clean products are dried with the patented VMH® (Venturi Mixed Hot air) technology. A high volume flow of normal circulating air is blown into a venturi nozzle. The resulting differential pressure there (passively) sucks on a small amount of very high temperature air. The resulting air mixture provides for uniformly high drying temperature (adjustable between 45 and 100 °C) all over the process chamber. Further advantages are robustness and low cost of ownership. Energy is only needed for a fan and the heating of a very small amount of air; the rest is executed by pressure differences and air duct geometry.

Maintenance: The system has a VARAccess® maintenance access system with recessed, variable doors and removable panels. In the maintenance area among others are the pump-out set, the optional re-dosage unit with space for a 25 liter detergent and a 5 l additive container as well as the MB cartridge for DI / DM water processing. Tank levels as well as pressure values and maintenance cycles are monitored by the PLC and displayed on the touch screen.



AQUBE® MH7

Fully automatic state of the art PowerSpray® XL "allround" cleaning system for tools and maintenance cleaning

Part number: 0905AQ7MH11 / 0905AQ7MH21 (HT version)



Main standard features

- PowerSpray® technology bundle: magnetically coupled XL-power pump unit, twofold ASYNCHRO® volume-spray rotorsystem with low maintenance PTFE mounted stainless steel rotors with PUSHFORCE® nozzles, "Option100" softwareprogram (100 freely selectable programs)
- PolyPower pump-nozzles configuration
- EATON Programmable Logic Controller (PLC) with module extension for special programming and technology extensions
- Smart Factory ready: DNAccess® (standard) for remote control (see options) and traceability with retractable touch monitor and integrated industrial PC (see options)
- High resolution 10" (1.024 x 600 px) display with capacitive multi-touch and intuitive process view
- Washing cart for solder frames, ESD-safe with grounding connection for the operator
- Fourfold alternating LED status light bar integrated in the system frame
- Full flow coarse filter (process chamber)
- VMH®-Turbo evaporative drying (control range approx. 45 - 100 °C)
- ClosedLoop reprocessing of cleaning and rinsing fluids
- HMA software and pre-equipping for HMA hardware (Heavy Metal Adsorber) for the cleaning circuit (see options)
- Spare space for MB / DI cartridge
- Exchange for rinse water and pump out unit
- Safety features: safety interlock on the process chamber door, overflow alarm for all tank sections, overheating protection for all heating and drying elements, end switches for all motor-driven valves and drives, personnel protection insulation
- VARlccess® service access with right and left-hinged side doors as well as unhinging possibility for side doors, front panel, and rear supply rail
- EDGELESS housing design. Doors, cover panels and hinges without edges, depot for traceability scanner and monitor in the right side panel
- Process sections made of electrolysis resistant elements

■ = AQUBE®-exclusive components (vs. kolb PSE Economy series)



AQUBE® MH7

Fully automatic state of the art PowerSpray® XL "allround" cleaning system for tools and maintenance cleaning

Part number: 0905AQ7MH11 / 0905AQ7MH21 (HT version)



Main options

- AOSelection® bundle to separate mandatory disposable and public sewage network dischargeable rinse water
- Automatic detergent concentration measurement / control
- Automatic monitoring of ionic residues contamination and gauging of rinse water quality
- Automatic re-dosage unit for 25 l detergent and 5 l additive container
- Automatic water change for cleaning circuit (only HT version)
- Descaling unit to reduce the lime content in the rinsing water
- Drawer inserts for container and machinery parts cleaning, ESD safe
- Drawer inserts for horizontal stencil cleaning with ASYNCHRO® stainless steel TopDown rotors with PUSHFORCE® nozzle
- Drip & storage reservoir
- Exhaust unit
- Fine filter for cleaning circuit
- Heater for tank A (cleaning) only for HT version
- HMA filter (Heavy Metal Adsorber) unit for the cleaning circuit
- HT Version for high temperature cleaning up to 80 °C
- MB / DI cartridge for deionized (DI) and demineralized (DM) water
- MediumWipe® unit for further optimization of detergent and rinsing fluid use
- Optional lacquering (frame rack and coverings)
- PolyPower XL configuration with XL-PolyPower pump unit
- Permanent automatic rotor run control
- Remote Control (remote monitoring, mailing, etc.)
- Sediment filter (tank A)
- Status light fivefold to display the current process state
- Traceability unit with PLC data scanner and retractable touch monitor and industrial PC with Intel processor
- XL-Power pump unit

■ = AQUBE®-exclusive components (vs. kolb PSE Economy series)



AQUBE® MH7

Fully automatic state of the art PowerSpray® XL "allround" cleaning system for tools and maintenance cleaning

Part number: 0905AQ7MH11 / 0905AQ7MH21 (HT version)



Internal rinse water processing (standard)

Options* for water management

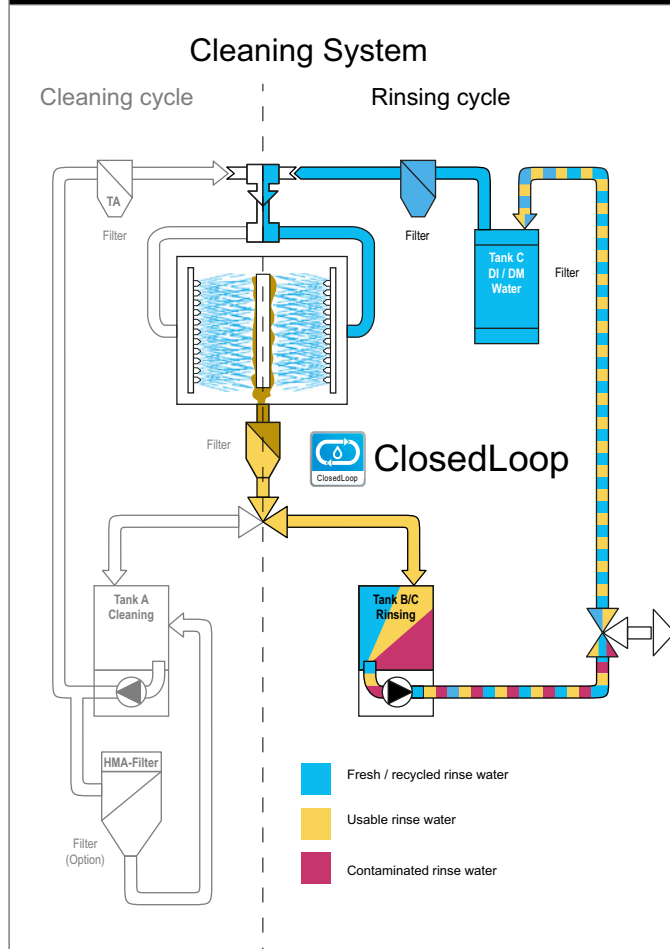

- **AOSelection® unit**
separates mandatory disposable sewage water from rinse water which can be discharged into a public sewage network.
- **WPSD IU SYMBIO-module**
Processes mandatory disposable sewage water to be discharged into a public sewage network.
- **WPCL IUT3 SYMBIO-module**
Recycles DI / DM water for recirculation and multiple reuse in the cleaning systems clear rinsing cycle.

* Operating companies of industrial cleaning systems are responsible for proper disposal of wastewater / rinse water and (wasted) cleaning detergent. Further information on wastewater management at www.kolb-ct.com/systems/water-management/, consulting requests to info@kolb-ct.com

■ = AQUBE®-exclusive components (vs. kolb PSE Economy series)

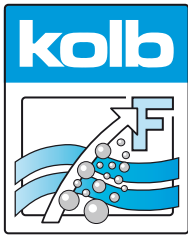

AQUBE® MH7



Fully automatic state of the art PowerSpray® XL "allround" cleaning system for tools and maintenance cleaning

Part number: 0905AQ7MH11 / 0905AQ7MH21 (HT version)

Technical data

Technology base	kolb PowerSpray®
Capacity	11 carriers up to 710 x 580, 28" x 23" or 640 x 640 mm, 25" x 25"
Process chamber dimensions	W 700 • D 720 • H 710 mm
Usable space lower drawer basket only	W 610 • D 625 • H 625 mm
Usable space utilizing three drawer baskets	W 610 • D 625 • H 140 mm (three times)
Volume tank A (cleaning)	ca. 55 l
Volume tank B / C (rinsing)	up to 35 l
Power supply	400 V AC, 16 A CEE / 3PH / 50 or 60 HZ
Power consumption	approx. 3.8 kW
Control system	PLC (EATON)
Temperature load	up to 55 °C (standard system), up to 80 °C (HT version)
Control range drying	approx. 45 - 100 °C
Filter system	up to four stage - 1. Full flow coarse filter < 2 mm, 2. Sediment filter inside the tank, 3. 20" fine filter (1 - 100µm - process dependent), 4. HMA filter
Supply connection 1 (tap water)	3/8", hose connection 14 mm with 30µm water filter (prov. by customer: inlet water quality < 350 µS conductance value (< 10° dH) or option descaling unit)
Supply connection 2 (DI / DM water)	1/4", hose connection 14 mm (DI-net prov. by customer or bridging to tap water)
Supply connection 3 (compressed air)	6 - 8 bar (100 l / min) for HT version or optional MediumWipe® process
Rinse water drain connection	3/4", hose connection 25 mm with integrated pump out system
Exhaust connection	Ø 160 mm, exhaust capacity 200 to 300m³ / h
Operating condition room temperature	20 - 35 °C
Operating noise	63 dB (A)
Foot print / Empty weight	1.170 x 1.350 mm / 480 kg

